

User Manual

Version 1.2

English

Contents

Keypad	2
Display	2
How to Use the Instrument	3
User Information	5
Safety Instructions	6
Technical Data	12
Message Codes	12

DISTO lite⁵ hand-held laser meter

Congratulations on your purchase of a DISTO.



This User Manual contains important safety directions (see section "Safety directions")

as well as instructions on use of the instrument.

Read carefully through the User Manual before you switch on the instrument.

Product identification

The identification label for your product is fitted on the front. The serial number is in the battery compartment.

Enter model and serial number in your User Manual, and always refer to this information when you need to contact your agency or service centre.

Model: DISTO

Serial no.:

Date of purchase:

Symbols used

The symbols used in the User Manual have the following meanings:



WARNING:

Indicates a potentially hazardous situation or an unintended use which, if not avoided, will result in death or serious injury.



CAUTION:

Indicates a potentially hazardous situation or an unintended use which, if not avoided, may result in minor injury and/or in appreciable material, financial and environmental damage.



Important paragraphs which must be adhered to in practice as they enabled the product to be used in a technically correct and efficient manner.

Keypad

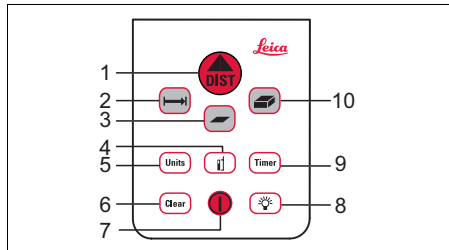

D5-Z1

- 1 Measurement
- 2 Distance measurement
- 3 Area
- 4 Reference
- 5 Units
- 6 Clear
- 7 On, off key
- 8 Illumination
- 9 Time delay release
- 10 Volume

Display

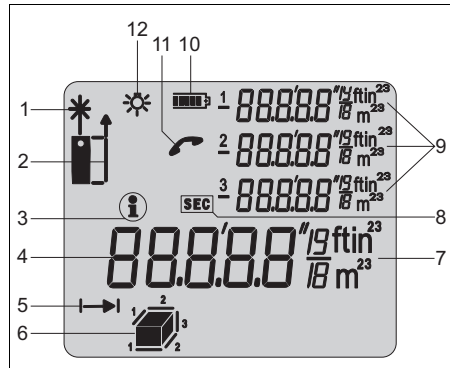

D5-Z2

- 1 Laser "On"
- 2 Reference (front / rear)
- 3 Information
- 4 Main display (e.g. measured distance)
- 5 Distance measurement
- 6 Areas/ volumes
- 7 Units incl. exponents (^{2/3})
- 8 Time symbol for time delay release

- 9 3 intermediate displays (e.g. to display intermediate values)
- 10 Battery display
- 11 Service instrument
- 12 Illumination (on/ off)

How to Use the Instrument

Inserting / replacing the batteries

- 1 Depress the locking clip and Slide the end piece to the right.

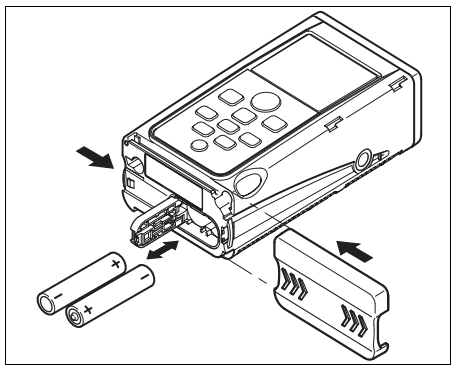

D5-Z3

- 2 Remove battery cover. Replace batteries.
-  appears on the display if battery voltage is too low.

For type of battery, refer to Technical Data.

 Fit batteries the right way round.

 Use only Alkaline batteries.

- 3 Push in end piece and listen for locking click sound.

DISTO Switching on/off

 Briefly press.

The illumination and Battery symbols are displayed until the first key press. The instrument can be switched off from any menu point.

 The instrument switches off automatically after 90 seconds if no key is pressed.

Clear key

 The clear key places the instrument in normal mode, resp. sets it to zero (=Clear).

This is possible before or after a measurement or a calculation is made.

While performing a calculation (area or volume) each single measurement can be deleted and remeasured.

Illumination

 Briefly press.

Illumination is switched on/off with a key press.

 Illumination switches off after 30 seconds if no key is pressed.

Reference setting



Press until desired reference setting appears.

Possible settings

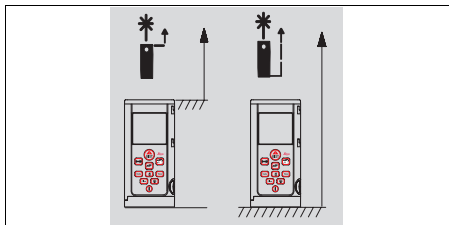

D5-Z4

front

rear



Setting remains until reference is changed and the instrument switched off automatically or manually.



Basic setting: rear reference

Measuring

Distance measurement



Press and the laser is switched on, the instrument is in "Pointing Mode".



A second press starts the **distance measurement**.

The result is displayed immediately in the selected unit.



With the instrument on and the laser off, it is in "Normal Mode".



With the laser on, it is in "Pointing Mode".

Measuring and aiming

DISTO is exceptional at "aiming" - e.g. in staking out distances.

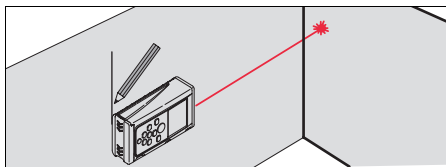

D5-Z5

Laser in continuous operation



Press until a long "beep" is heard. Now the laser is activated permanently.



A distance measurement is triggered each time the key is pressed.



Press to end continuous laser operation.

Time delay release



Press and hold until desired time delay has been reached (max. 60 seconds).



appears on the display.

Once the key is released, the remaining seconds (e.g. 59, 58, 57...) are displayed, until measuring.

The last 5 seconds are counted down with a "beep".

After the last "beep", the measurement is made and the value displayed.

Calculations

Area



Press



appears on the display.
The side to be measured blinks.

Make 2 measurements (l x w).

The result and the two partial results appear on the display.

Volume



Press



appears on the display.
The side to be measured blinks.

Make 3 measurements (l x w x h).

The result and the three partial results appear on the display.

Setting the units



Press until the current unit (e.g. 0.000m) is displayed.

Selectable units:

- m (mm) = 0.000 m
- m (cm) = 0.00 m*
- ft = 0.00 ft*
- ft in 1/16 = 0.00 ¹/₁₆ ft in
- 14' 06" 1/16 = ' " ¹/₁₆*
- in = 0.0 in*
- in 1/16 = 0 ¹/₁₆ in*

* for USA only

User Information

Range

Increased range:

At night, at dusk and when target area is in the shade.

Reduced range:

By mat green and blue surfaces (also by plants or trees).

Rough surfaces

On a rough surface (e.g. coarse plaster) measure against the centre of the illuminated area.

To avoid measuring to the bottom of plaster joints:

Use target plate, 3M "Post-it" or board.

Transparent surfaces

To avoid measuring errors, do not measure towards colorless liquids (like water) or (dust free) glass.

For materials and liquids unfamiliar to you always take a trial measurement.



When aiming through panes of glass, or if there are several objects in the line-of-sight erroneous measurements can occur.

Wet, smooth or high-gloss surfaces

- 1 Aiming at a "flat" angle deflects the laser beam. The DISTO may receive a signal that is too weak (error message 255).
- 2 If aiming at a right angle, the DISTO may receive a signal that is too strong (error message 256).

Inclined, round surfaces

Can be measured with the laser.

Requirement: There is enough area on the target surface for the laser spot.

Free-handed aiming

(approx. 20 - 40 m):

Use target plate 563875 (DIN C6) resp. 723385 (DIN A4).

- White surface: to 30 m
- Brown surface: from 30 m on

Safety Instructions

The following directions should enable the person responsible for the DISTO, and the person who actually uses the instrument, to anticipate and avoid operational hazards.

The person responsible for the instrument must ensure that all users understand these directions and adhere to them.

Use of the instrument

Permitted use

The permitted use of the DISTO are the following:

- Measuring distances
- Computing areas and volumes

Prohibited use

- Using the instrument without instruction
- Using outside the stated limits
- Deactivation of safety systems and removal of explanatory and hazard labels
- Opening of the equipment by using tools (screwdrivers, etc.), as far as not specifically permitted for certain cases

- Carrying out modification or conversion of the product
- Use after misappropriation
- Use of accessories from other manufacturers without the express approval of Leica Geosystems.
- Deliberate or irresponsible behaviour on scaffolding, when using ladders, when measuring near machines which are running, or near parts of machines or installations which are unprotected
- Aiming directly into the sun
- Deliberate dazzling of third parties; also in the dark
- Inadequate safeguards at the surveying site (e.g. when measuring on roads, etc.)



WARNING

Prohibited use can lead to injury, malfunction, and material damage. It is the task of the person responsible for the instrument to inform the user about hazards and how to counteract them. The DISTO is not to be operated until the user has been instructed.

Limits of use



See section "Technical Data"

Environment:

Suitable for use in an atmosphere appropriate for permanent human habitation. Cannot be used in an aggressive or explosive environment. Use in rain is permissible for limited periods.

Areas of responsibility

Responsibilities of the manufacturer of the original equipment Leica Geosystems AG, CH-9435 Heerbrugg (brief Leica Geosystems):

Leica Geosystems is responsible for supplying the product, including the User Manual and original accessories, in a completely safe condition.

Responsibilities of the manufacturer of non-Leica accessories:



The manufacturers of non-Leica accessories for the DISTO are responsible for developing, implementing and communicating safety concepts for their products. They are also responsible for the effectiveness of these safety concepts in combination with the Leica Geosystems equipment.

Responsibilities of the person in charge of the instrument:



WARNING:

The person responsible for the instrument must ensure that the equipment is used in accordance with the instructions. This person is also accountable for the

deployment of personnel and for their training and for the safety of the equipment when in use.

The person in charge of the instrument has the following duties:

- To understand the safety instructions on the product and the instructions in the User Manual.
- To be familiar with local safety regulations relating to accident prevention.
- To inform Leica Geosystems immediately if the equipment becomes unsafe.

Hazards in use

Important hazards in use

**WARNING:**

The absence of instruction, or the inadequate imparting of instruction, can lead to incorrect or prohibited use, and can give rise to accidents with far-reaching human, material and environmental consequences.

Precautions:

All users must follow the safety instructions given by the manufacturer and the directions of the person responsible for the instrument.

**CAUTION:**

Watch out for erroneous distance measurements if the instrument is defective or if it has been dropped or has been misused or modified.

Precautions:

Carry out periodic test measurements. Particularly after the instrument has been subject to abnormal use, and before, during and after important measurements.

Make sure the DISTO optics is kept clean and that there is no mechanical damage to the bumpers.

**WARNING:**

Insufficient securing or marking of your measurement site could cause a dangerous situation on the public highway, building site, or in the factory, etc.

Precautions:

Always ensure your measurement site is appropriately secured. Obey the local accident prevention regulations, and road safety rules, at all times.

**CAUTION:**

In using the instrument for distance measurements or for positioning moving objects (e.g. cranes, building equipment, platforms, etc.) unforeseen events may cause erroneous measurements.

Precautions:

Only use this product as a measuring sensor, not as a control device. Your system must be configured and operated in such a way, that in case of an erroneous measurement, malfunction of the device or power failure due to installed safety measures (e.g. safety limit switch), it is assured that no damage will occur.

**WARNING:**

Dispose of the equipment appropriately in accordance with the regulations in force in your country. Always prevent access to the equipment by unauthorized personnel.

Laser classification

The DISTO produces a visible laser beam which emerges from the front of the instrument.

It is a Class 2 laser product in accordance with:

- IEC60825-1 : 1993 "Radiation safety of laser products"
- EN60825-1 : 1994 "Radiation safety of laser products"

It is a Class II laser product in accordance with:

- FDA 21CFR Ch.I §1040 : 2001 (US Department of Health and Human Service, Code of Federal Regulations)

Laser Class 2/ II products:

Do not stare into the laser beam or direct it towards other people unnecessarily. Eye protection is normally afforded by aversion responses including the blink reflex.



WARNING:

Looking directly into the beam with optical aids (e.g. binoculars, telescopes) can be hazardous.

Precautions:

Do not look directly into the beam with optical aids.



CAUTION:

Looking into the laser beam may be hazardous to the eyes.

Precautions:

Do not look into the laser beam. Make sure the laser is aimed above or below eye level. (particularly with fixed installations, in machines, etc.)



WARNING:

Looking right at the reflected laser beam in a DISTO operated with telescopic viewfinder could be dangerous when you aim at areas that reflect like a mirror, or emit reflections unexpectedly (e.g. a mirror, metallic surfaces, windows, prisms, liquids).

Precautions:

If you are using a telescopic viewfinder, do not aim at areas that are reflective like a mirror, or which could produce unintended reflections (e.g. mirrors, metallic surfaces, windows, prisms).

Electromagnetic compatibility (EMC)

The term "electromagnetic compatibility" is taken to mean the capability of the DISTO to function smoothly in an environment where electromagnetic radiation and electrostatic discharges are present, and without causing electromagnetic interference to other equipment.



WARNING:

Electromagnetic radiation can cause interference in other equipment.

Although the DISTO meets the strict regulations and standards which are in force in this respect, Leica Geosystems cannot completely exclude the possibility that interference may be caused to other equipment.

FCC statement (applic. in U.S.)

WARNING:

This equipment has been tested and found to comply with the limits for a Class B digital device, pursuant to part 15 of the FCC Rules. These limits are designed to provide reasonable protection against harmful interference in a residential installation.

This equipment generates, uses and can radiate radio frequency energy and, if not installed and used in accordance with the instructions, may cause harmful interference to radio communications.

However, there is no guarantee that interference will not occur in a particular installation.

If this equipment does cause harmful interference to radio or television reception, which can be determined by turning the equipment off and on, the user is encouraged to try to correct the interference by one or more of the following measures:

- Reorient or relocate the receiving antenna.
- Increase the separation between the equipment and receiver.
- Connect the equipment into an outlet on a circuit different from that to which the receiver is connected.

- Consult the dealer or an experienced radio/TV technician for help.

WARNING:

Changes or modifications not expressly approved by Leica Geosystems for compliance could void the user's authority to operate the equipment.

Product labelling:

This device complies with part 15 of the FCC Rules. Operation is subject to the following two conditions: (1) This device may not cause harmful interference, and (2) this device must accept any interference received, including interference that may cause undesired operation.



Labelling

Maximum radiant power:	0.95mW
Emitted wavelength:	620-690nm
Standard applied:	EN60825-1: 1994 IEC60825-1: 1993

D5-Z6

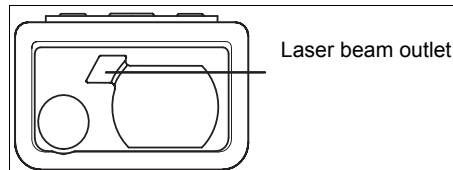

D5-Z7

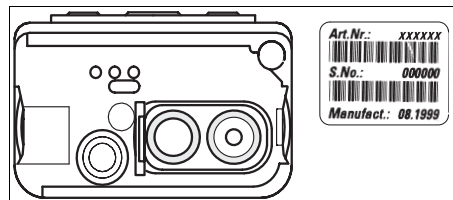

D5-Z8



D5-Z9

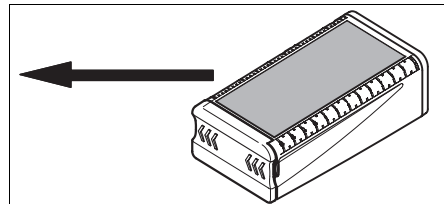

D5-Z10

Beam divergence	0.16 x 0.6 mrad
Pulse duration	15×10^{-9} s
Max. radiant power * Measurement uncertainty	0.95 mW* ±5%
Max. radiant power per pulse	8 mW



CAUTION:

Allow only authorized Leica Geosystems service workshops to service the instruments.

Technical Data

Measuring accuracy (2x standard deviation)	typ.: $\pm 3\text{mm}$ / max.: $\pm 5\text{mm}$
Smallest unit displayed	1mm
Range	0.2m up to 200m * **
Time for a measurement dist / trc	0.5...ca.4s / 0.16...ca.1s
∅ Laser spot (at distance)	6 / 30 / 60 mm (10 / 50 / 100 m)
Illumination	✓
Multiline display	✓
Aiming aid	✓
Time delay release	✓
Battery, Type AA, 2x 1.5V	up to 10'000 measurements (only with Alkaline batteries!)
Splash and dust proof	IP54 acc. IEC529: splash proof, dust proof
Dimension and weight	142 x 73 x 45 mm, 315g
Measuring accuracy of bubble	1°
Temperature range	
Storage	-25°C to +70°C (-13°F to +158°F)
Operating	-10°C to +50°C (-14°F to +122°F)

All rights reserved to make technical changes.

* Display unit as off 100m : 1 cm

** At long range ± 5 ppm ($\pm 0,5\text{mm}/ 100 \text{m}$) plus short range error.

Message Codes

Error message



appears beside the message number on the display.

Message Code	Cause	Remedy
204	Calculation error	Repeat procedure
252	Temperature too high, above 50°C (measuring)	Cool down instrument
253	Temperature too low, below -10°C (measuring)	Warm up instrument
255	Receiver signal too weak, measurement time too long, distance <200 mm	Use target plate measurement time >10 sec.
256	Received signal too powerful	Use target plate (correct side)
257	Wrong measurement, ambient brightness too high	Use target plate
260	Laser beam interrupted	Repeat measurement
	All other messages	Call service "System"



In case of this message switch on/off instrument several times and check if message is still displayed. Then call service and specify the message displayed.

Care

Look after the optical surfaces with the same care that you would apply to spectacles, cameras and field glasses.